



Steel Shipping Container Institute Interior Drum Particulate Cleanliness Standard Procedure

Page 1 of 6

Introduction

This test describes the method to measure the cleanliness of drums during production. The advantage of the method is that it can be performed during production without disturbing the product flow. The test is as follows: Three drums are vacuum cleaned with a specified vacuum cleaner using a long pipe. The contamination is gathered on a filter with a standard diameter and mesh size. The discoloration and/or the increase in weight of the filter are an indication of the level of drum contamination. The method described is the SSCI standard method for measuring drum contamination under production conditions.

2. Apparatus

- Vacuum cleaner: 1.5 horsepower shop vacuum cleaner (1.0-1.3 kW), The vacuum cleaner should blow approximately 11 US gallon (40 litres) of air per sec. When fitted with the extension tube and filter, the flow should be around 4 US gallons (15 litre) per second.
- The flexible tube on the vacuum cleaner is to be used only for this test. (flexible tubes are never flat inside and are easily contaminated if used for other purposes.)
- Filter disks of polyester filter material (Supplier filter sheet: Sefar, Internet: Sefar.com, Type: PET 1000-190-31-W-TW). The disks must be stored in a glass jar or similar container to prevent exposure to dirt, dust and other airborne particulate. The disks should be pre-weighted to the nearest 0.1 mg.
- A stainless steel extension tube that will reach to the bottom of a large drum.
- A filter holder with couplings and a steel mesh to support the filter(see attachment 2 for principle)
- A balance capable of measurements to the nearest 0.1 mg.
- Microscope slides (approximately: 2" x 3") or any other translucent holder for the filters.
- Tweezers



3. Test procedure

Note: Before starting the test, purge the tubes of any particles by running the vacuum for 3 minutes and 15 seconds in open air without drums.

1. Before inserting the filter in the holder, inspect it for any particulate contamination and verify that it has been properly weighed. If the filter is suspect, discard the disk and use another one.
2. The steel mesh and filter should be inserted into the holder, with the filter laying flat on the mesh. Connect the vacuum hose and close the unit by turning the cap.
3. Randomly select three drums and lift and drop each drum three times (on the floor, not on rubber) to dislodge any loose particles from the sides and the head.
4. Carefully remove the bung, taking care to avoid particulates from breaking away from the closure threads.
5. Carefully insert the vacuum extension tube to reach the bottom of the drum.
6. Turn on the vacuum cleaner, and carefully without scraping the bottom, move the extension tube around the bottom chime. Once the circuit of the bottom is complete, move the tube in a zigzag pattern across the bottom to ensure that the whole bottom surface is vacuumed. Repeat this operation once more. This should take 1 minute per drum.
7. Conduct the same procedure on the second and third drums. (Make sure the vacuum cleaner is switched off between the drums to avoid unwanted material from being sucked in.)
8. After the last drum, keep the vacuum cleaner running for 15 seconds, remove the tube from the drum, keep the end of the pipe in the air, move and tap the flexible tube to get all particles out of the tube and then switch the off motor.
9. Keeping the extension tube vertical, remove the section holding the filter from the vacuum extension tube.
10. Hold the connector over the filter. Tap lightly on the connector to dislodge any remaining particulates and using the tweezers, carefully remove the filter. Place the filter on the glass slide (or holder).
11. Place another slide on the top (or close the holder) and securely seal with tape. Label with relevant information.
12. The sample should then be removed from the slide (or holder) and weighed. (If the test is performed in a laboratory setting where the filter will be weighed immediately, steps 10, 11 and 12 can be omitted).
13. The difference between the before and after filter weight, divided by 3, is the average weight contamination per drum.

4. Precautions

1. Avoid damage to the threads when opening the 2" closure
2. Avoid contact between the opening threads and the extension tube.
3. Avoid running the cleaner while the vacuum pipe is outside the container (except for the 15 seconds after the last drum.)
4. Do not use the vacuum cleaner for any other purpose (If accidentally done, the flexible tube should be replaced because the old one is too severely contaminated).
5. Avoid damage to the lining by careless use of the probe.
6. Keep equipment clean at all times.
7. Use the right type of filter. Other types might reduce the air flow through the system and so the cleaning efficiency.



5. Results

- Contamination per drum is expressed by:

Weight filter in mg – original weight in mg = x mg

3

- Residues can also be analyzed with a microscope.

Revision: R-1
Date: 3/16/06

R-1 - Relocate filter unit before flexible hose



Attachment 1: Picture of system

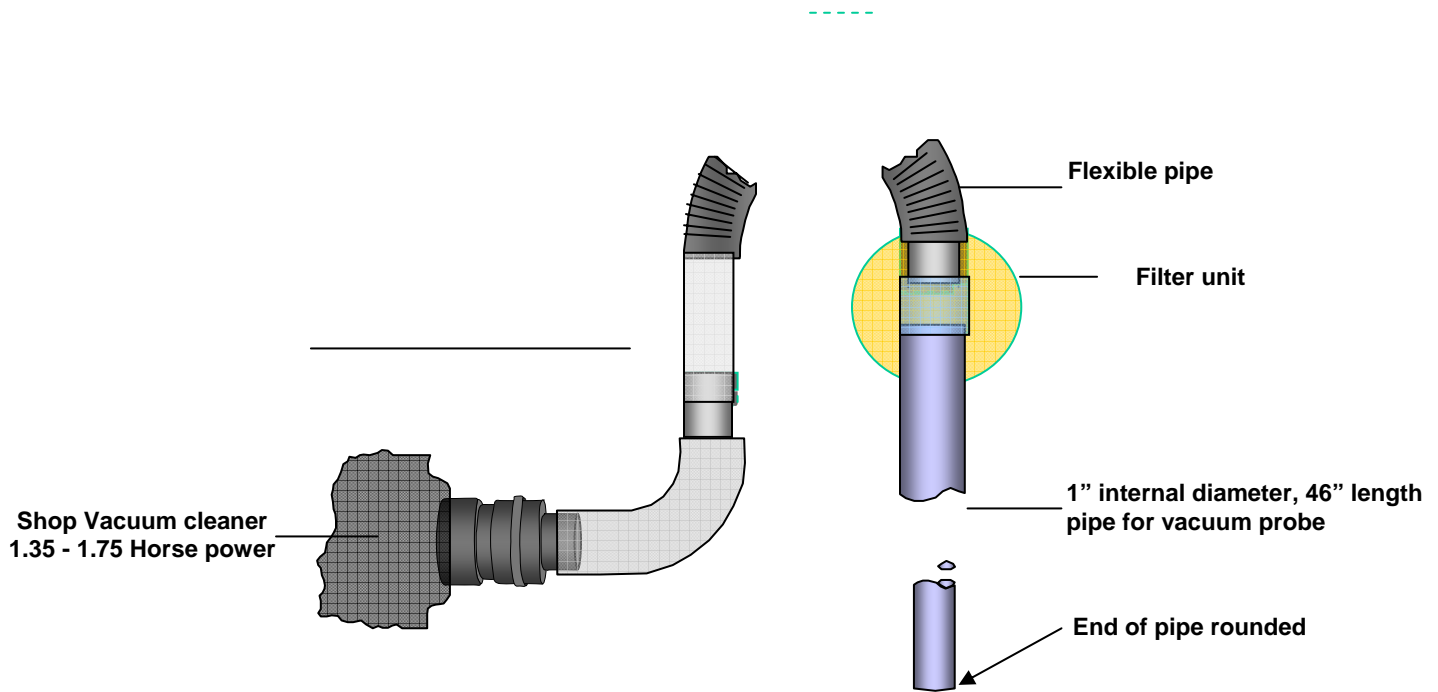

Attachment 2: Details of filter unit

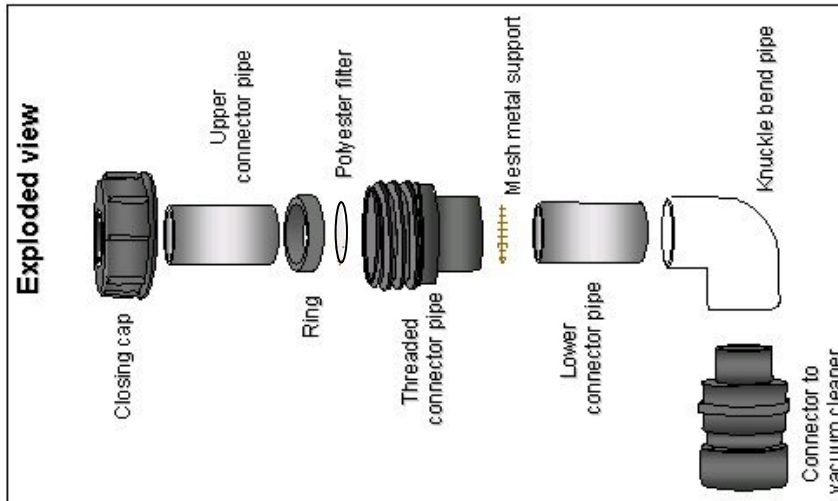

Non standard part details

Connector to vacuum cleaner



Threaded connector



Ring



Polyester filter
(diameter 1 1/4",
480 mesh screen:
opening width 16
micron, threaded
width 31 micron)



Mesh metal support
(diameter 1 1/4",
40 mesh, (mesh
width approx..
1/32")



Standard part details

Standard USA material (cut to required length)

Knuckle bend pipe
internal diameter 1 5/16"

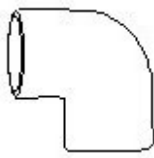

Upper & lower connector pipe
external diameter 1 5/16"
internal diameter 1"
length 3"



Closing cap standard Tri-sure
with hole approx.. 1 3/8"

